

MASTER GUN VISE™ MULTI-AXIS BENCH-MOUNT VISE WITH TORQ-LOK™

THE ULTIMATE FOUNDATION FOR GUN DIY®



The first real bench vise made exclusively for guns and gun tools. Whether you're building and customizing, repairing, cleaning or mounting scopes and accessories, this vise is precision-engineered to improve every part of the of GUN DIY experience. Quickly reposition your gun to any orientation without ever removing it from the vise. For high-torque applications, such as barrel installations, inserting the Torq-Lok™ will turn your vise into a secure, single-positioned vise. Use the removable and reversible Gun-Fit™ jaw sleeves for a specific gun grip or turn the leveling knob for simple scope mounting and leveling. Build. Customize. Repair. Mount. Clean. Upgrade to Master Grade®.

ONE VISE TO RULE THEM ALL.

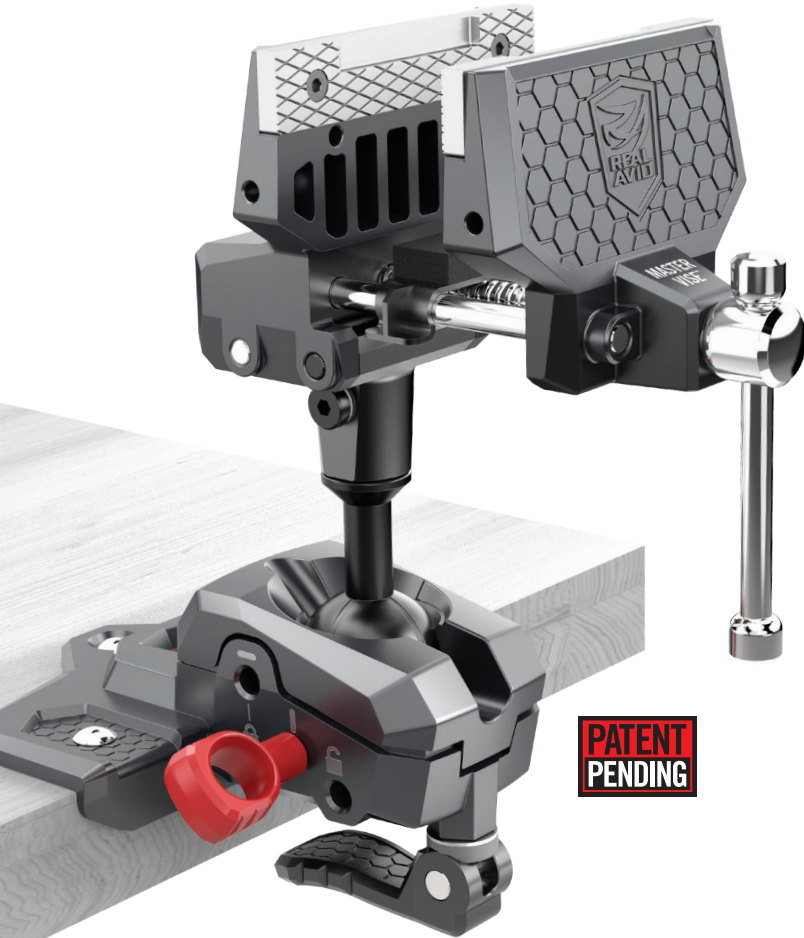

**PATENT
PENDING**

BUILD, REPAIR, CUSTOMIZE GUNS
MOUNT SCOPES
INSTALL ACCESSORIES
CLEAN GUNS

QUICKLY POSITION AND REPOSITION THE GUN FOR OPTIMAL WORKFLOW.



Position the lower receiver to install pivot pin, spring & detent. (*Smart-Fit sold separately*)

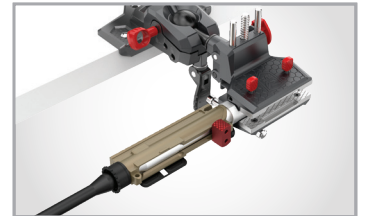

Optimal lock-down positioning for high-torque applications. (*Lug-Lok sold separately*)



Angle the lower receiver for fast and easy installation of bolt release pin.

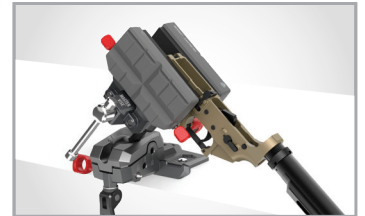

Optimally position lower receiver to install buffer and buffer detent pin.

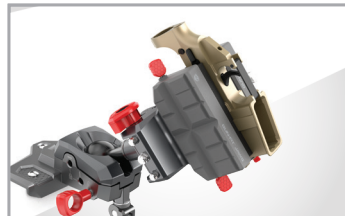

Ideal positioning for inverted maintenance and installations.

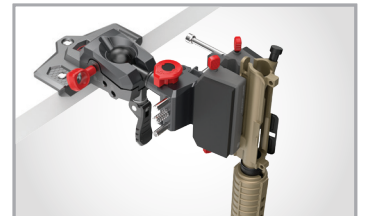

Position the barrel and upper receiver downward into the trash for bore and barrel cleaning.

MULTI-AXIS BALL & SOCKET BASE WITH
TORQ-LOK™ AND SPEED CAM™
+ CONFIGURABLE GUN-FIT™ JAWS

MASTER GUN VISE™

MULTI-AXIS BENCH-MOUNT VISE WITH TORQ-LOK™

WORK THE WAY YOU WANT TO WORK.

QUICKLY POSITION AND REPOSITION THE GUN FOR OPTIMAL WORKFLOW.

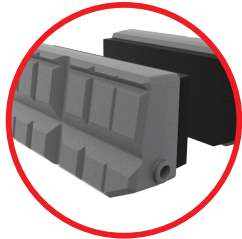
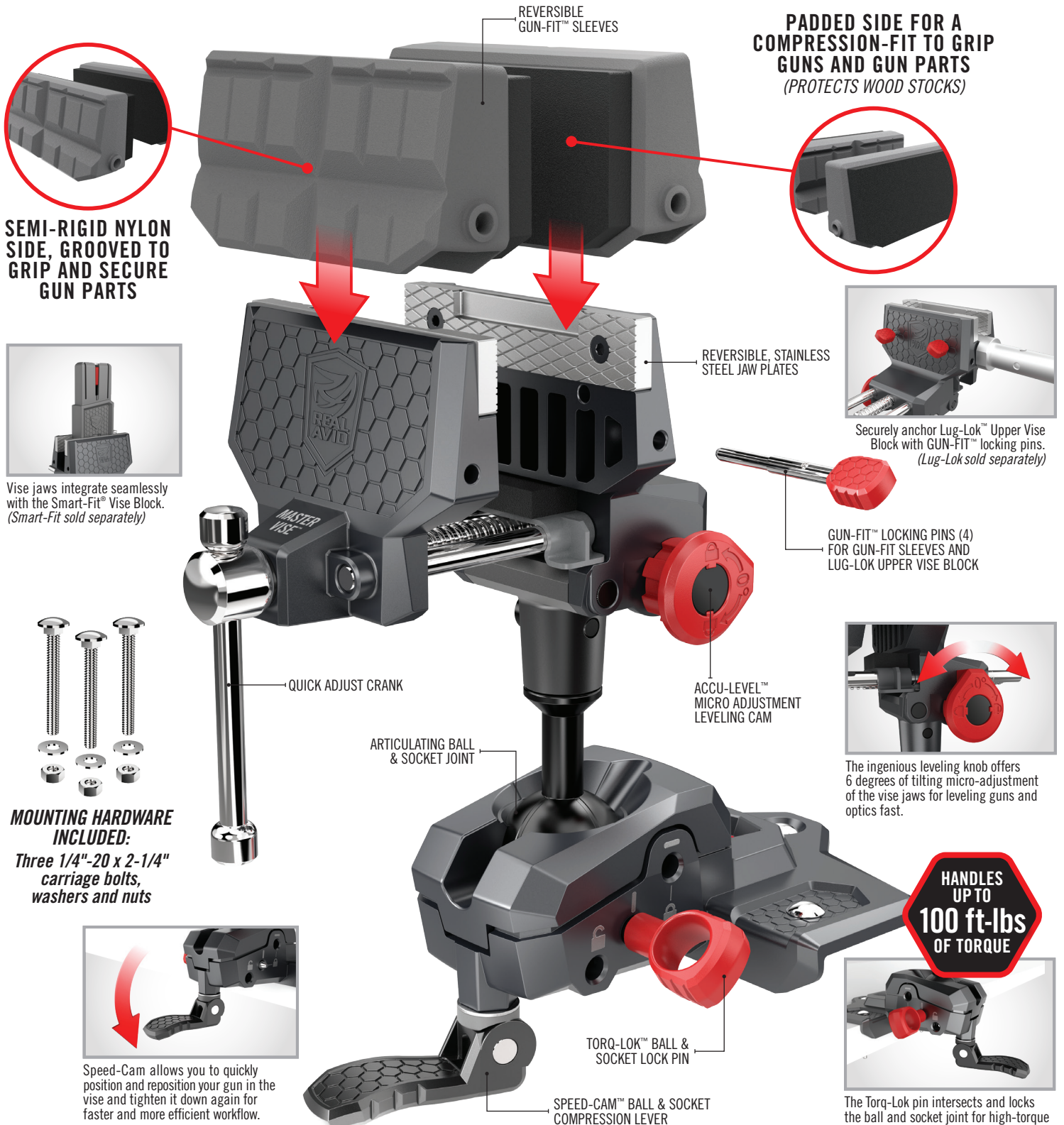

SEMI-RIGID NYLON SIDE, GROOVED TO GRIP AND SECURE GUN PARTS

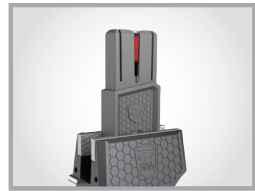

Vise jaws integrate seamlessly with the Smart-Fit® Vise Block. (Smart-Fit sold separately)



MOUNTING HARDWARE INCLUDED:

Three 1/4\"-20 x 2-1/4\" carriage bolts, washers and nuts

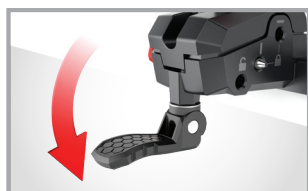

Speed-Cam allows you to quickly position and reposition your gun in the vise and tighten it down again for faster and more efficient workflow.

REVERSIBLE GUN-FIT™ SLEEVES

PADDED SIDE FOR A COMPRESSION-FIT TO GRIP GUNS AND GUN PARTS (PROTECTS WOOD STOCKS)



REVERSIBLE, STAINLESS STEEL JAW PLATES

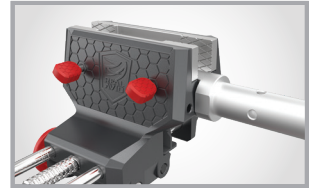

Securely anchor Lug-Lok™ Upper Vise Block with GUN-FIT™ locking pins. (Lug-Lok sold separately)

GUN-FIT™ LOCKING PINS (4) FOR GUN-FIT SLEEVES AND LUG-LOK UPPER VISE BLOCK

ACCU-LEVEL™ MICRO ADJUSTMENT LEVELING CAM

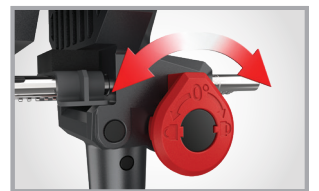

The ingenious leveling knob offers 6 degrees of tilting micro-adjustment of the vise jaws for leveling guns and optics fast.

HANDLES UP TO 100 ft-lbs OF TORQUE

TORQ-LOK™ BALL & SOCKET LOCK PIN



SPEED-CAM™ BALL & SOCKET COMPRESSION LEVER

ALWAYS REFER TO MANUFACTURER'S SPECS BEFORE WORKING ON FIREARMS.

MASTER GUN VISE™

MULTI-AXIS BENCH-MOUNT VISE WITH TORQ-LOK™

QUICKLY POSITION AND REPOSITION THE GUN FOR OPTIMAL WORKFLOW.

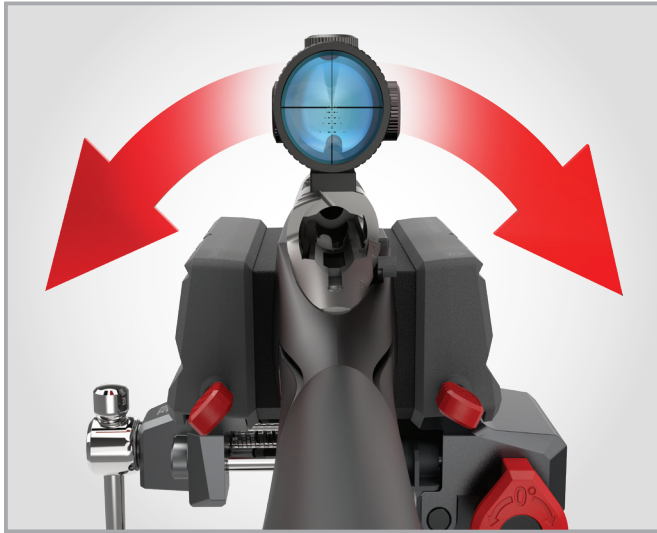

SCOPE MOUNTING MADE EASY.

ACCU-LEVEL™ QUICKLY AND EASILY LEVELS THE GUN (WHILE IN THE VISE) FOR ACCURATE SCOPE MOUNTING.



The ingenious leveling knob offers 6 degrees of tilting micro-adjustment of the vise jaws for leveling guns and optics fast.

REVERSIBLE GUN-FIT™ JAW SLEEVES.

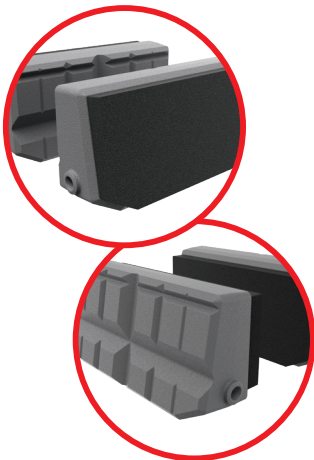

PADDED FOR A COMPRESSION FIT TO GRIP GUNS AND GUN PARTS



SAFELY GRIP ANY SURFACE



VERSATILE PISTOL AND GUN MAINTENANCE

SEMI-RIGID NYLON, GROOVED TO GRIP GUN PARTS SUCH AS RIFLE BARRELS, PICATINNY RAILS AND BOLT CARRIERS



ARCA-SWISS COMPATIBLE



INSTALL OR UPGRADE TRIGGERS



PICATINNY RAIL COMPATIBLE



QUICKLY SECURE SUPPRESSORS

WARNING: This product can expose you to chemicals including Nickel (Metallic), which is known to the State of California to cause cancer. For more information, go to www.P65Warnings.ca.gov.



5480 NATHAN LANE NORTH, SUITE 120
MINNEAPOLIS, MN 55442 800.286.0567
info@realavid.com | RealAvid.com
© 2022 NEW REVO BRAND GROUP, LLC.

