

MASTER GUN VISE™

MULTI-AXIS BENCH-MOUNT VISE
WITH TORQ-LOK™

USER MANUAL



***WARNING: TO AVOID DAMAGE, READ USER MANUAL
AND REFER TO YOUR GUN MANUAL PRIOR TO USE.***



MASTER GUN VISE™

MULTI-AXIS BENCH-MOUNT VISE WITH TORQ-LOK™

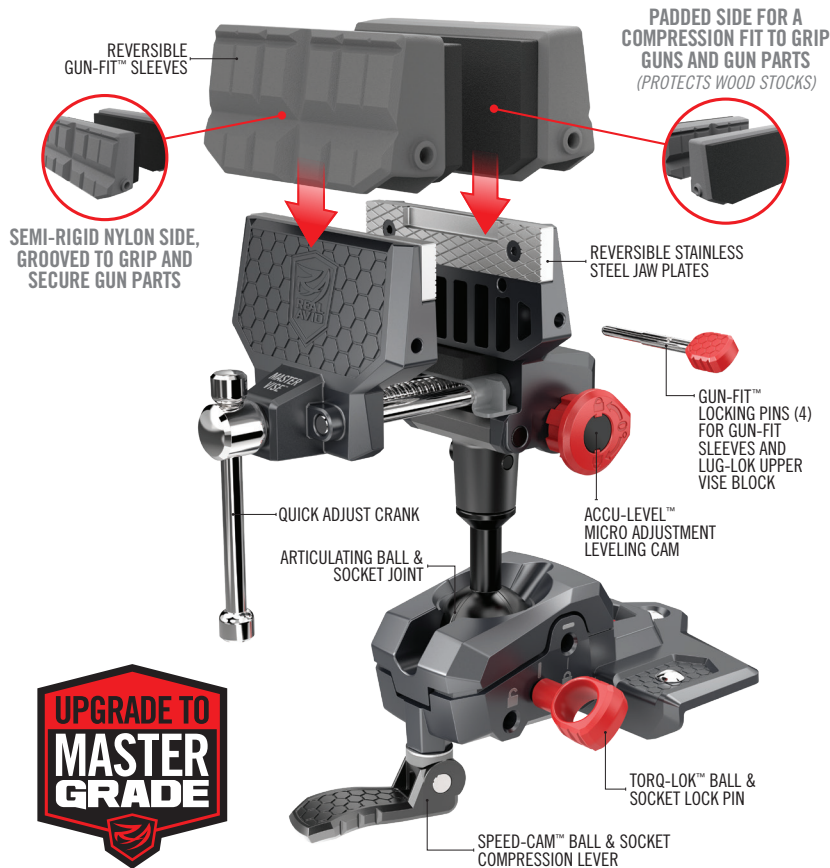

THE ULTIMATE FOUNDATION FOR GUN DIY.®

The first real bench vise made exclusively for guns and gun tools. Whether you're building and customizing, repairing, cleaning or mounting scopes and accessories, this vise is precision engineered to improve every part of the GUN DIY® experience. Quickly reposition your gun to any orientation without ever removing it from the vise. Insert the Torq-Lok™ pin into one of the eight preset positions for applying heavy force. Use the removable and reversible Gun-Fit™ jaw sleeves for a specific gun grip or turn the leveling knob for simple scope mounting and leveling. Build. Customize. Repair. Mount. Clean. Upgrade to Master Grade.

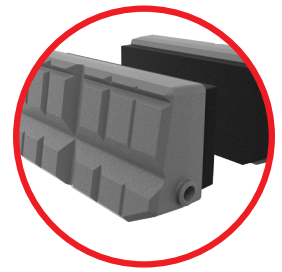
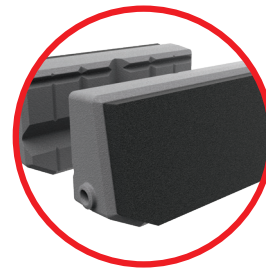

REVERSIBLE GUN-FIT™ JAW SLEEVES.

PADDED FOR A COMPRESSION FIT TO GRIP GUNS AND GUN PARTS



SAFELY GRIP ANY SURFACE



VERSATILE PISTOL AND GUN MAINTENANCE

SEMI-RIGID NYLON, GROOVED TO GRIP GUN PARTS SUCH AS RIFLE BARRELS, PICATINNY RAILS AND BOLT CARRIERS



ARCA-SWISS COMPATIBLE



INSTALL OR UPGRADE TRIGGERS



PICATINNY RAIL COMPATIBLE

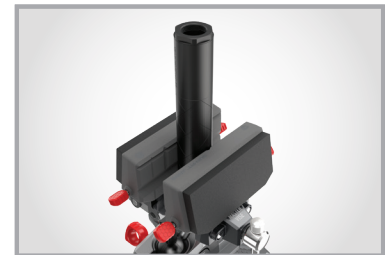

QUICKLY SECURE SUPPRESSORS

GUN SAFETY IS A PRIORITY. Before working on any firearm, make sure the gun is unloaded, the chamber is empty, and the gun is pointed in a safe direction.

WARNING

Before undertaking any type of work on your firearm – including disassembly, cleaning, modification, and reassembly – you must know how to unload, remove the magazine, and conduct a safety check of the firearm both visibly and physically. You must know how to safely operate the action of the firearm and how to combine and separate the upper receiver from the lower receiver.

After performing work on your firearm, you must properly perform all appropriate safety procedures such as checking headspace and confirming proper function of the fire control group. Failure to do so can result in damage or destruction of your firearm and/or injury or death to you and/or any bystanders in the vicinity when the firearm is loaded and/or fired. In all cases, you assume all liability for damages from any modifications made to your firearm.

If you have any doubt about your skills, ability, or understanding of the firearm and/or the Armorer's Master Vise, you must seek the assistance of an experienced armorer or gunsmith.

The Master Gun Vise is a medium duty vise made from durable materials but is not indestructible. If damage occurs to the vise, do not attempt to continue using it. Using a damaged vise increases the potential for damaging gun components and personal injury.

All components that you select for your gun should come with information from the manufacturer. You must carefully read and understand this information before proceeding with any installation. Torque specs vary from one manufacturer to another. We recommend confirming all torque specs with the component's manufacturer.

Before using the Master Gun Vise, you must **MAKE SURE THAT THE FIREARM IS UNLOADED AND SAFE** to work on. It is your responsibility to exercise caution during the use of this vise, especially when applying torque. Make sure to follow the manufacturer's recommended torque setting when applying torque.

DO NOT APPLY MORE THAN 100ft-lbs OF TORQUE AT ANY TIME.

To avoid injury or damage to your firearm check for correct fit of all implements carefully before use. To avoid damaging your firearm, make sure that you are using the proper devices to securely hold it in place (barrel blocks, upper vise blocks, lower vise blocks etc.).

CAUTION: Maximum distance between stainless steel jaws is 3.5 inches. Opening jaws wider than 3.5 inches reduces thread engagement and stability. The front jaws can be completely removed for care and maintenance when desired and therefore, the threaded drive shaft and guide rods do not have retaining pins and will detach at the end of the drive shaft. Use caution during this process to avoid the front jaws falling out and hitting the ground or landing on operator's foot.

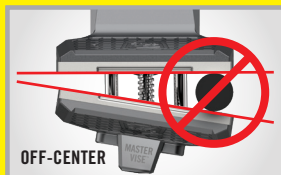

DO NOT APPLY EXCESSIVE OR UNEVEN FORCE TO VISE JAWS.

The uniquely large jaw shape allows for enhanced capabilities with gun stocks and vise blocks. However, this enlarged jaw does come with limitations. Damage can result if uneven clamping force is applied (when clamped objects are off-center), or excessive clamping force is applied beyond the vise jaw's limitations. In either scenario you will begin to notice flexing. Excessive flexing can lead to permanent damage. Keep these limitations in mind when working.

INSTRUCTIONS MOUNTING THE VISE

Before installing, be sure the table or workbench has a square edge and is a solid mounting surface that can handle 200ft-lbs of force. Position vise in the reverse 45° position to prevent tipping forward and falling during installation. Next, place the vise in desired location on square edge of a table or workbench. Mark the center point of the three mounting holes. Remove vise from location and use a 1/4" bit to drill the three holes. Place the vise back into position and install the three 1/4"-20 x 2-1/4" carriage bolts, washers and nuts. Recommended torque of 40in-lbs using a 7/16" socket.



Position vise in the reverse 45° position during installation

This vise was designed for a solid bench-top with no obstructive bracing. If attempting to install on a bench-top with obstructive bracing, 1/4" x 1-1/2" lag screws can be substituted in place of the carriage bolts provided. In case your bench-top is thinner than 1-1/2", a wooden spacer on the underside of the bench-top is recommended. (*Lag screws not included*)

ARTICULATING BALL & SOCKET JOINT

The base of the vise consists of an Articulating Ball & Socket Joint, Speed Cam™ Ball & Socket Locking Lever and Torq-Lok™ Pin. The Speed Cam™ adjusts the clamping force of the socket to hold the articulating ball and shaft in place. Once the desired position is attained, the user can simply pivot the Speed Cam down to hold the ball joint in place, and up to allow movement. The Speed Cam force can also be adjusted by turning the Speed Cam under the base. For high torque applications during assembly/disassembly of a firearm, the Torq-Lok Pin should be used with the Speed Cam engaged for maximum hold. Reference the guide lines on the ball to indicate which positions will allow the Torq-Lok Pin to intersect the ball and socket and lock it in place. There are four vertical locking positions and four horizontal locking positions. There are three holes in the base for the Torq-Lok pin. The first hole, indicated by an unlock symbol, is where you can store the pin when not in use. The other two holes are for locking the ball within the socket and are indicated by a horizontal or vertical line for the position intended. If the Torq-Lok pin doesn't go in smoothly, do not use a hammer or try to force pin as damage to the pin or vise could occur. Reposition ball and socket and retry inserting Torq-Lok pin.



Guide lines for Torq-Lok Pin locking positions.



Speed-Cam allows you to quickly position and reposition your gun in the vise and tighten it down again for faster and more efficient workflow.

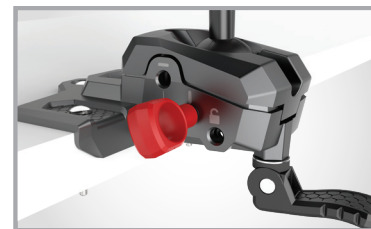

The Torq-Lok pin intersects and locks the ball and socket joint for high torque applications.

WORK THE WAY YOU WANT TO WORK.

QUICKLY POSITION AND REPOSITION THE GUN FOR OPTIMAL WORKFLOW.



Position the lower receiver to install pivot pin, spring & detent. (*Smart-Fit sold separately*)

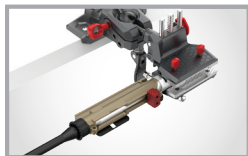

One of eight optimal lock-down positions for high torque applications. (*Lug-Lok sold separately*)



Angle the lower receiver for fast and easy installation of bolt release pin.



Optimally position lower receiver to install buffer and buffer detent pin.

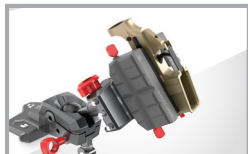

Ideal positioning for inverted maintenance and installations.

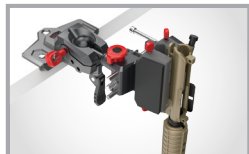

Position the barrel and upper receiver downward into the trash for bore and barrel cleaning.



Vise jaws integrate seamlessly with the Smart-Fit® Vise Block. (*Smart-Fit sold separately*)

SMART-FIT® MOUNTING

The vise jaws have a recessed pocket in the clamping plates. This is designed to help secure a Real Avid Smart-Fit™ AR15 Vise Block (sold separately) into the vise and prevent movement and rotation during high torque applications. If you do not have a Smart-Fit AR15 Vise Block, simply remove the screws from the jaw plates and rotate 180° allowing for a flat clamping surface.

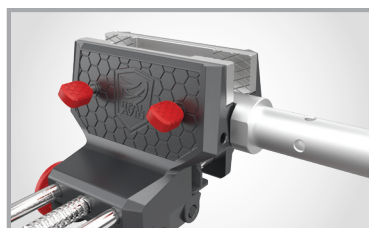

Securely anchor Lug-Lok™ Upper Vise Block with GUN-FIT™ locking pins. (*Lug-Lok sold separately*)

LUG-LOK™ MOUNTING

The vise jaws have two holes which allow the clamping of a Real Avid AR15 or AR10 Lug-Lok Upper Vise Block (sold separately). The Gun-Fit Locking Pins are inserted from the back side of the jaws, through the Lug-Lok and into the opposite side of the vise. Once pins are inserted, fully tighten vise jaws. See image for recommended placement of the Lug-Lok.

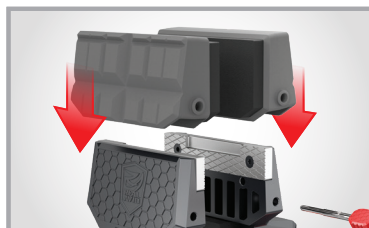

The versatile and modular Gun-Fit™ Sleeves allow nearly any gun or gun part to be safely and securely clamped in the vise for unlimited Gun DIY® tasks.

GUN-FIT™ SLEEVES

The Gun-Fit Sleeves provide two different surfaces for ideal working conditions. The foam side should be used to hold wood stocks or non-uniform gun parts. We recommend not to overexpose the foam to solvents as this will accelerate degradation. Allowing guns or parts to sit in the foam jaws for long periods of time can also deform the foam. The reverse side of the jaws are a hard nylon intended to hold shapes

and surfaces such as Arca-Swiss, picatinny, gun barrels or other small hard-to-hold gun parts. These covers are great for lightly securing guns and parts but are not intended for any type of torque related assembly and doing so could cause marring of product or damage to jaws, or possibly allowing firearm to fall from vise. The use of alternating jaw surfaces (i.e. one foam and one nylon) is also not recommended as they were not designed to work in this manner. The foam-covered guard rail inside the vise can be centered or removed depending on your specific need. The four Gun-Fit Locking Pins are used to retain the covers on the jaws, the pins should be inserted into the mount holes at both ends.

ACCU-LEVEL™

The Accu-Level Micro-Adjustment Leveling Cam on the side of the vise is used to easily level your firearm. This operation is for mounting an optic and properly aligning the reticle. To use this feature, level the gun approximately with the Ball & Socket and Speed Cam. Clamp it in place. Next, pull the Accu-Level Micro-adjustment Leveling Cam out from the vise and rotate to the left or right. Rotating the cam clockwise will result in up to 3 degrees right-side tilt of the vise. Rotating the cam counter-clockwise will result in up to 3 degrees left-side tilt of the vise. Return cam to the left or right to engage the retaining pin when not in use.

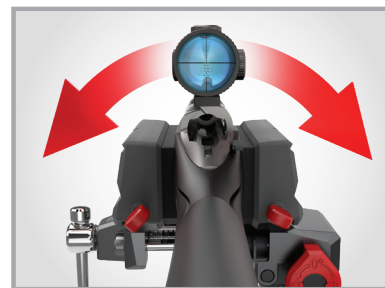

SCOPE MOUNTING MADE EASY.

ACCU-LEVEL™ QUICKLY AND EASILY LEVELS THE GUN (WHILE IN THE VISE) FOR ACCURATE SCOPE MOUNTING.



The ingenious leveling knob offers 6 degrees of tilting micro-adjustment of the vise jaws for leveling guns and optics.

CARE & MAINTENANCE

You already take good care of your guns - you should treat your tools the same way. This is a medium duty vise and should be treated as such. Heavy hammering or high amounts of force could cause the vise to fail. The high-quality coatings and platings provide enhanced corrosion resistance, but that does not mean that the Master Gun Vise is rustproof. We recommend applying a very minimal coating of lightweight oil onto metal surfaces periodically.

It is also important to inspect and ensure the ball and socket are kept clean and free of debris prior to, and during use. We also recommend applying a high-pressure grease to the ball and socket as well as the drive shaft of the jaws periodically. When using the Master Gun Vise be aware of potential pinch points.



Some of the potential pinch points.



WARRANTY

LIMITED – 3 YEAR WARRANTY: Master Gun Vise is guaranteed free of defects in materials and workmanship for three years from date of original purchase. Real Avid will replace or repair any product that proves defective upon our inspection. Use of the Master Gun Vise for anything other than its intended purpose is considered misuse and voids this warranty. For warranty service, contact us at RealAvid.com. This warranty excludes damage resulting from deliberate or accidental misuse. Warranty does not cover rust, stains or corrosion, or normal wear and tear. Repair or replacement is the exclusive remedy under this warranty. Real Avid, its partners, and affiliates are not liable for incidental or consequential damage resulting from use. Some states do not allow exclusion or limitation of incidental or consequential damages; therefore, the above exclusions may not apply to you. This warranty gives you specific legal rights, and you may have other rights, which vary from state to state.

NOTES:

TO FRIENDS AND CUSTOMERS: As the owners of Real Avid, authenticity isn't just a strategy here. It's a guiding philosophy. It arises out of our faith and personal relationships with Jesus Christ. We know that our creativity and success ultimately comes from Him. He cares about each of us and about our customers. We're not perfect, but we are committed to following Him in our personal and business lives.

We look forward to growing our relationship with you and continuing to earn our place.



5480 Nathan Lane North, Suite 120
Minneapolis, MN 55442 USA

RealAvid.com • 800-286-0567